

PAPER TOWEL DISPENSER WH5



260 x 225 x 120 mm

approx. 300 paper towels

- Paper towel dispenser in robust, germ-reducing and easy-care stainless steel (AISI 304).
- All-stainless steel housing open at the top; visible surfaces satin finished and brushed.
- Designed for approx. 300 standard paper towels in zigzag fold.
Paper size (folded): 240-250 mm x 100-115 mm.
- Inspection slot to indicate fill level.
- Refillable from the top.
- Mounting: For glueing or with three screws through key holes and one optional anti-theft hole in the back wall.
- Delivery includes fixing material and first fill.
- Weight, including single package: 3.3 kg



Suggested text for specifications:

Paper towel dispenser in stainless steel (AISI 304) for surface mounting. All-stainless steel housing open at the top; visible surfaces satin finished and brushed. Filling quantity approx. 300 paper towels. Inspection slot to indicate fill level. Refillable from the top. Delivery includes fixing material and first fill with paper.

Dimensions: 260 x 225 x 120 mm

Article No. WH5

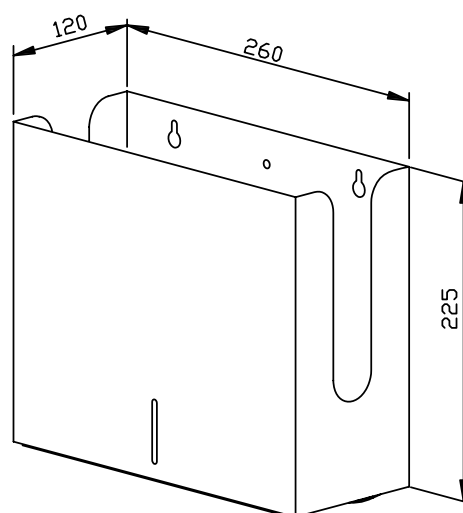

Available surfaces	ID No.
satin finished (standard)	727 346

Ernst Wagner GmbH & Co. KG

Ernst-Abbe-Straße 21 · D-72770 Reutlingen · Tel.: +49712151539-0 · Fax: -20
info@wagner-ewar.de · www.wagner-ewar.de

WAGNER
E W A R